





Set-up Guide





Hybrid Fibre Coaxial (HFC)

Box contents

Brown Box (provided by nbn™)

-  1 x nbn™ connection box
-  1 x nbn™ power adaptor
-  2 x nbn™ coaxial cables
-  1 x nbn™ splitter
(if you receive pay TV or another cable service over the cable connection)

Branded Modem Box

-  2 x Ethernet cables
-  1 x Wi-Fi Modem
-  1 x Power adaptor
-  2 x Phone cable

1 Set up the nbn™ connection box

a.

Once we've sent you an SMS to let you know that you're ready to connect, refer to diagram 1 below to plug in the cables.

b.

Connect your nbn™ connection box straight to your wall outlet, unless you have Pay TV.

If you have Pay TV through your cable connection, you will need to use the supplied splitter from your brown box and follow the shaded area in diagram 1 below to plug in the cables.

c.

You'll know it's ready when all four lights on the front are solid green. This could take up to 10 minutes.

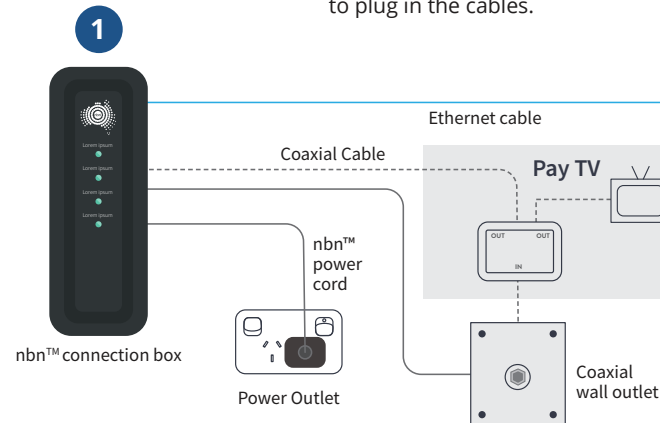

No solid green lights?

Check all cables are securely plugged into the nbn™ connection box and at the wall.

Still not working after 10 minutes?

If the lights are still not green, try connecting the nbn™ connection box to a different coaxial wall outlet, if available.

If this doesn't work, you can contact us using one of the options on your modem sleeve.

2 Set up your supplied Wi-Fi modem

a.

Refer to diagram 2 below to plug in the cables.

b.

When the first four lights are solid green, you're all connected. This could take up to 15 minutes.

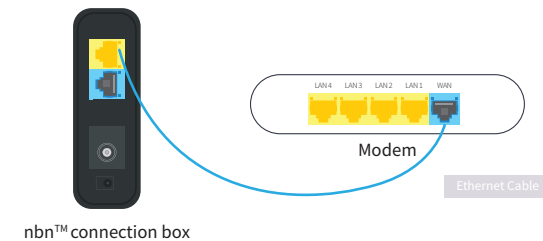
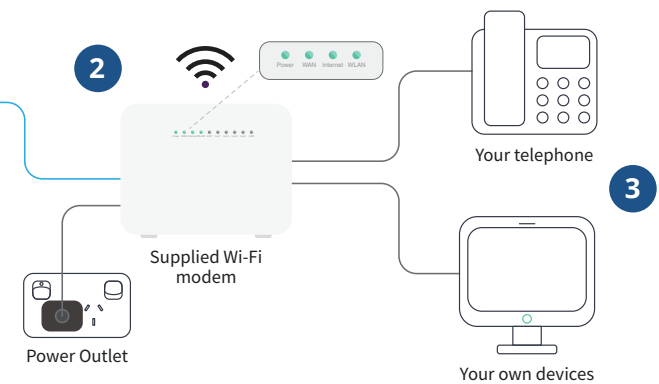

3 Connect your devices

You can choose to connect your devices to the Internet via Wi-Fi or Ethernet cable. There are instructions on how to connect devices and phone services in the supplied Set-up Guide inside your Wi-Fi modem box.